







Nazwij obrazki w każdym rzędzie. Z pierwszych głosek utwórz nowe słowo.  
Odszukaj odpowiedni obrazek i wstaw go w miejsce znaku zapytania.







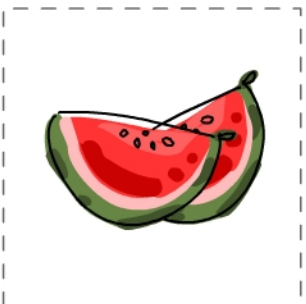

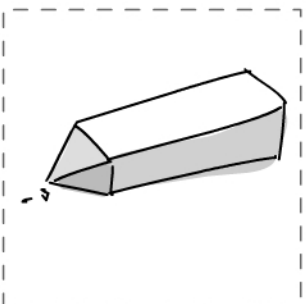
					
--	---	---	--	---	---







					
---	---	---	---	---	---



					
--	--	--	---	--	--



					
--	---	---	--	---	---

